

## CATALOG CRUCI CARDANICE

### 1. Cruci cardanice Della Concordia

<u>D</u>	<u>L</u>	<u>FIG</u>	<u>COD</u>
<u>14,00</u>	<u>36,00</u>	<u>4</u>	<u>CR143</u>
<u>15,00</u>	<u>38,00</u>	<u>2</u>	<u>CR12</u>
<u>15,00</u>	<u>40,00</u>	<u>2</u>	<u>CR13</u>
<u>15,00</u>	<u>40,10</u>	<u>1</u>	<u>CR30</u>
<u>15,00</u>	<u>40,10</u>	<u>2</u>	<u>CR31</u>
<u>15,00</u>	<u>41,00</u>	<u>2</u>	<u>CR32</u>
<u>15,05</u>	<u>38,50</u>	<u>2</u>	<u>CR33</u>
<u>16,05</u>	<u>38,90</u>	<u>2</u>	<u>CR163</u>
<u>16,05</u>	<u>38,90</u>	<u>3</u>	<u>CR168</u>
<u>17,00</u>	<u>41,00</u>	<u>1</u>	<u>CR34</u>
<u>17,00</u>	<u>41,00</u>	<u>4</u>	<u>CR35</u>
<u>17,00</u>	<u>42,00</u>	<u>1</u>	<u>CR36</u>
<u>17,00</u>	<u>47,00</u>	<u>2</u>	<u>CR37</u>
<u>18,00</u>	<u>46,50</u>	<u>2</u>	<u>CR39</u>
<u>18,00</u>	<u>47,00</u>	<u>2</u>	<u>CR1</u>
<u>18,00</u>	<u>47,00</u>	<u>1</u>	<u>CR14</u>
<u>18,00</u>	<u>19,80</u>	<u>1</u>	<u>CR293</u>
<u>18,00</u>	<u>47,00</u>	<u>4</u>	<u>CR184</u>

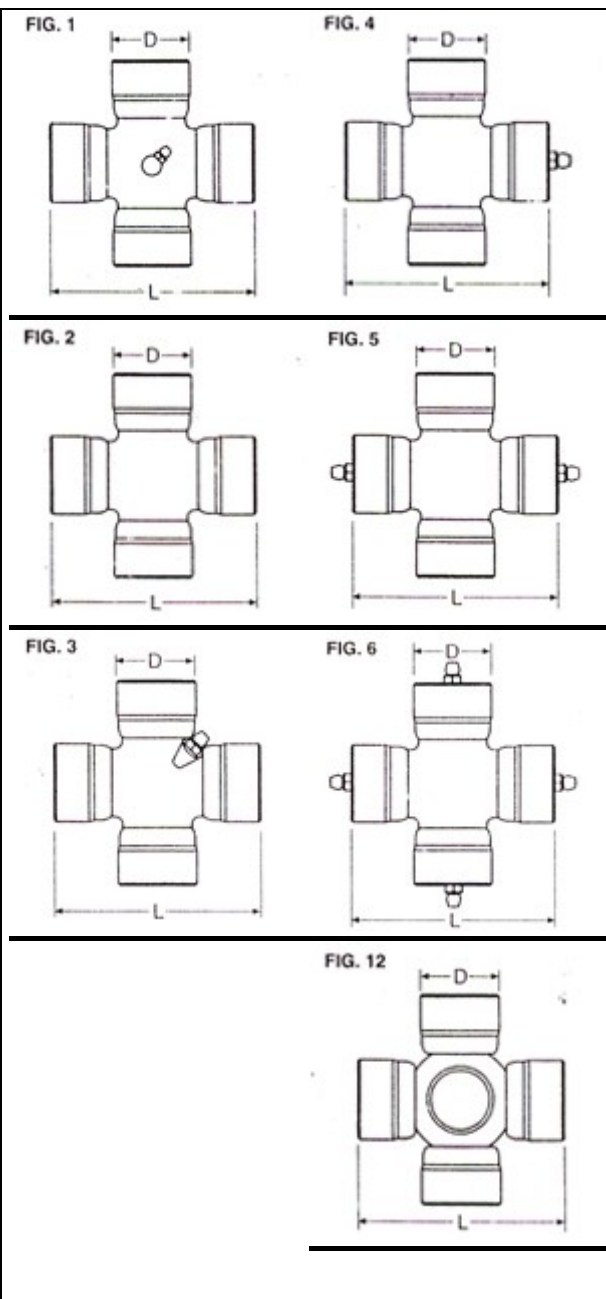

<u>19,00</u>	<u>44,00</u>	<u>2</u>	<u>CR40</u>
<u>19,00</u>	<u>48,00</u>	<u>1</u>	<u>CR194</u>
<u>19,00</u>	<u>48,00</u>	<u>4</u>	<u>CR41</u>
<u>19,00</u>	<u>48,00</u>	<u>2</u>	<u>CR42</u>
<u>19,00</u>	<u>48,00</u>	<u>5</u>	<u>CR43</u>
<u>19,00</u>	<u>48,50</u>	<u>2</u>	<u>CR44</u>
<u>19,00</u>	<u>49,20</u>	<u>1</u>	<u>CR45</u>
<u>19,00</u>	<u>49,20</u>	<u>4</u>	<u>CR46</u>
<u>19,00</u>	<u>52,00</u>	<u>1</u>	<u>CR195</u>
<u>19,00</u>	<u>53,80</u>	<u>1</u>	<u>CR196</u>
<u>20,00</u>	<u>44,00</u>	<u>2</u>	<u>CR28</u>
<u>20,00</u>	<u>44,34</u>	<u>1</u>	<u>CR743</u>
<u>20,00</u>	<u>47,00</u>	<u>2</u>	<u>CR282</u>
<u>20,00</u>	<u>48,00</u>	<u>2</u>	<u>CR49</u>
<u>20,00</u>	<u>50,00</u>	<u>1</u>	<u>CR205</u>
<u>20,00</u>	<u>52,40</u>	<u>1</u>	<u>CR50</u>
<u>20,00</u>	<u>54,60</u>	<u>1</u>	<u>CR51</u>
<u>20,00</u>	<u>54,60</u>	<u>4</u>	<u>CR52</u>
<u>20,00</u>	<u>57,00</u>	<u>4</u>	<u>CR53</u>
<u>20,00</u>	<u>57,00</u>	<u>1</u>	<u>CR54</u>
<u>20,00</u>	<u>58,00</u>	<u>1</u>	<u>CR56</u>
<u>20,00</u>	<u>59,80</u>	<u>2</u>	<u>CR57</u>
<u>20,06</u>	<u>52,40</u>	<u>1</u>	<u>CR58</u>
<u>20,06</u>	<u>52,80</u>	<u>2</u>	<u>CR59</u>
<u>20,06</u>	<u>59,80</u>	<u>1</u>	<u>CR61</u>

## 2. Cruci cardaniche Della Concordia

<u>D</u>	<u>L</u>	<u>Fig.</u>	<u>Cod</u>
<u>20,50</u>	<u>56,60</u>	<u>1</u>	<u>CR62</u>
<u>21,00</u>	<u>44,00</u>	<u>1</u>	<u>CR241</u>
<u>22,00</u>	<u>48,00</u>	<u>1</u>	<u>CR224</u>
<u>22,00</u>	<u>49,00</u>	<u>2</u>	<u>CR63</u>
<u>22,00</u>	<u>50,20</u>	<u>1</u>	<u>CR15</u>
<u>22,00</u>	<u>50,34</u>	<u>1</u>	<u>CR64</u>
<u>22,00</u>	<u>52,00</u>	<u>2</u>	<u>CR222</u>
<u>22,00</u>	<u>52,00</u>	<u>1</u>	<u>CR225</u>
<u>22,00</u>	<u>54,00</u>	<u>1</u>	<u>CR2</u>
<u>22,00</u>	<u>54,80</u>	<u>1</u>	<u>CR16</u>
<u>22,00</u>	<u>55,60</u>	<u>1</u>	<u>CR65</u>
<u>22,00</u>	<u>57,00</u>	<u>1</u>	<u>CR227</u>
<u>22,00</u>	<u>58,00</u>	<u>1</u>	<u>CR228</u>
<u>22,00</u>	<u>58,00</u>	<u>4</u>	<u>CR66</u>
<u>22,00</u>	<u>58,60</u>	<u>1</u>	<u>CR269</u>
<u>22,00</u>	<u>58,60</u>	<u>4</u>	<u>CR270</u>
<u>22,00</u>	<u>58,90</u>	<u>1</u>	<u>CR67</u>
<u>22,00</u>	<u>58,90</u>	<u>4</u>	<u>CR68</u>
<u>22,00</u>	<u>58,90</u>	<u>5</u>	<u>CR69</u>
<u>22,00</u>	<u>58,90</u>	<u>2</u>	<u>CR71</u>
<u>22,00</u>	<u>62,00</u>	<u>2</u>	<u>CR72</u>
<u>22,00</u>	<u>63,10</u>	<u>12</u>	<u>CR273</u>
<u>22,00</u>	<u>63,50</u>	<u>2</u>	<u>CR741</u>
<u>22,00</u>	<u>67,10</u>	<u>2</u>	<u>CR742</u>
<u>22,03</u>	<u>58,80</u>	<u>4</u>	<u>CR73</u>
<u>22,06</u>	<u>64,15</u>	<u>2</u>	<u>CR75</u>
<u>22,06</u>	<u>64,50</u>	<u>2</u>	<u>CR76</u>
<u>22,22</u>	<u>63,55</u>	<u>4</u>	<u>CR77</u>
<u>22,22</u>	<u>73,80</u>	<u>1</u>	<u>CR78</u>

FIG. 1

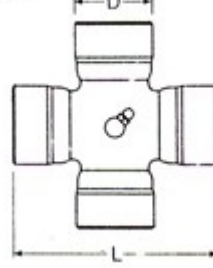

FIG. 4

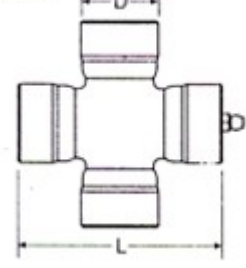

FIG. 2

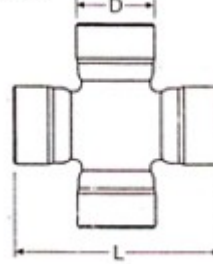

FIG. 5

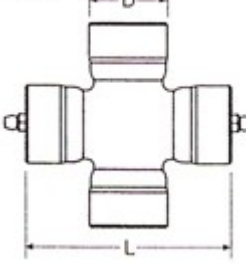

FIG. 3

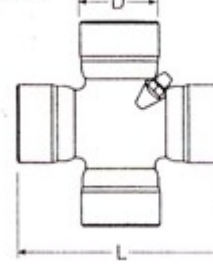

FIG. 6

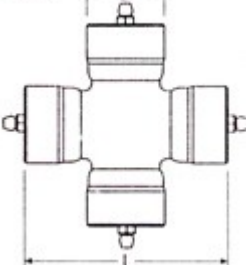
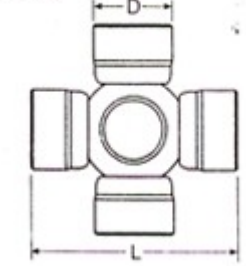

FIG. 12



<u>22,22</u>	<u>74,44</u>	<u>1</u>	<u>CR79</u>
<u>23,00</u>	<u>52,25</u>	<u>1</u>	<u>CR235</u>
<u>23,00</u>	<u>58,20</u>	<u>4</u>	<u>CR84</u>
<u>23,00</u>	<u>58,20</u>	<u>1</u>	<u>CR85</u>
<u>23,84</u>	<u>61,30</u>	<u>2</u>	<u>CR38</u>
<u>23,84</u>	<u>61,30</u>	<u>3</u>	<u>CR05</u>
<u>23,84</u>	<u>61,30</u>	<u>1</u>	<u>CR3</u>
<u>23,84</u>	<u>61,30</u>	<u>4</u>	<u>CR238</u>
<u>23,84</u>	<u>61,30</u>	<u>1</u>	<u>CR17</u>
<u>23,84</u>	<u>61,30</u>	<u>5</u>	<u>CR289</u>
<u>23,84</u>	<u>62,50</u>	<u>1</u>	<u>CR236</u>
<u>23,84</u>	<u>62,50</u>	<u>2</u>	<u>CR288</u>
<u>24,00</u>	<u>60,24</u>	<u>12</u>	<u>CR240</u>
<u>24,00</u>	<u>61,00</u>	<u>2</u>	<u>CR246</u>
<u>24,00</u>	<u>61,00</u>	<u>1</u>	<u>CR87</u>
<u>24,00</u>	<u>62,50</u>	<u>2</u>	<u>CR88</u>
<u>24,00</u>	<u>62,50</u>	<u>1</u>	<u>CR89</u>
<u>24,00</u>	<u>63,30</u>	<u>2</u>	<u>CR25</u>
<u>24,00</u>	<u>63,30</u>	<u>4</u>	<u>CR243</u>

<u>D</u>	<u>L</u>	<u>Fig.</u>	<u>Cod</u>
<u>24,00</u>	<u>66,00</u>	<u>2</u>	<u>CR245</u>
<u>24,00</u>	<u>68,00</u>	<u>1</u>	<u>CR248</u>
<u>24,00</u>	<u>74,60</u>	<u>2</u>	<u>CR247</u>
<u>24,00</u>	<u>78,80</u>	<u>2</u>	<u>CR91</u>
<u>24,05</u>	<u>73,00</u>	<u>3</u>	<u>CR249</u>
<u>24,05</u>	<u>74,60</u>	<u>2</u>	<u>CR244</u>
<u>24,05</u>	<u>74,60</u>	<u>12</u>	<u>CR283</u>
<u>24,05</u>	<u>74,60</u>	<u>3</u>	<u>CR295</u>
<u>25,00</u>	<u>56,90</u>	<u>1</u>	<u>CR101</u>
<u>25,00</u>	<u>63,80</u>	<u>4</u>	<u>CR102</u>
<u>25,00</u>	<u>64,20</u>	<u>1</u>	<u>CR103</u>
<u>25,00</u>	<u>72,00</u>	<u>1</u>	<u>CR104</u>
<u>25,00</u>	<u>76,80</u>	<u>3</u>	<u>CR105</u>

FIG. 1

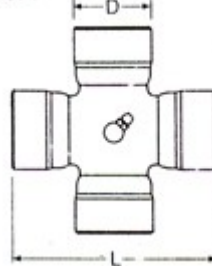

FIG. 4

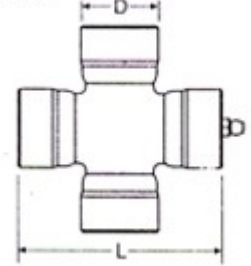

FIG. 2

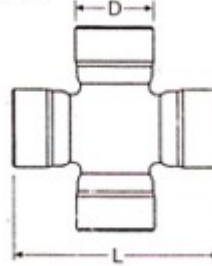
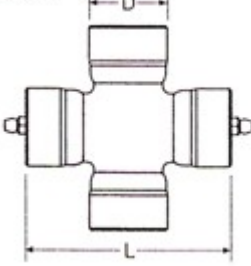

FIG. 5



<u>25,00</u>	<u>77,80</u>	<u>3</u>	<u>CR106</u>
<u>25,02</u>	<u>60,03</u>	<u>2</u>	<u>CR107</u>
<u>25,58</u>	<u>99,16</u>	<u>1</u>	<u>CR122</u>
<u>26,00</u>	<u>69,80</u>	<u>1</u>	<u>CR123</u>
<u>26,00</u>	<u>69,80</u>	<u>4</u>	<u>CR124</u>
<u>26,00</u>	<u>69,80</u>	<u>2</u>	<u>CR125</u>
<u>26,00</u>	<u>70,00</u>	<u>1</u>	<u>CR267</u>
<u>26,00</u>	<u>72,10</u>	<u>1</u>	<u>CR126</u>
<u>26,94</u>	<u>61,85</u>	<u>4</u>	<u>CR132</u>
<u>26,98</u>	<u>70,00</u>	<u>1</u>	<u>CR19</u>
<u>26,98</u>	<u>74,60</u>	<u>1</u>	<u>CR18</u>
<u>27,00</u>	<u>60,00</u>	<u>2</u>	<u>CR133</u>
<u>27,00</u>	<u>62,00</u>	<u>2</u>	<u>CR276</u>
<u>27,00</u>	<u>66,30</u>	<u>1</u>	<u>CR134</u>
<u>27,00</u>	<u>70,00</u>	<u>2</u>	<u>CR135</u>
<u>27,00</u>	<u>70,00</u>	<u>1</u>	<u>CR10</u>
<u>27,00</u>	<u>70,90</u>	<u>1</u>	<u>CR279</u>
<u>27,00</u>	<u>70,90</u>	<u>2</u>	<u>CR136</u>
<u>27,00</u>	<u>71,50</u>	<u>2</u>	<u>CR137</u>
<u>27,00</u>	<u>74,60</u>	<u>2</u>	<u>CR277</u>
<u>27,00</u>	<u>74,60</u>	<u>1</u>	<u>CR4</u>
<u>27,00</u>	<u>74,60</u>	<u>3</u>	<u>CR48</u>
<u>27,00</u>	<u>74,60</u>	<u>4</u>	<u>CR138</u>
<u>27,00</u>	<u>74,60</u>	<u>5</u>	<u>CR290</u>
<u>27,00</u>	<u>75,10</u>	<u>1</u>	<u>CR275</u>
<u>27,00</u>	<u>80,00</u>	<u>1</u>	<u>CR278</u>
<u>27,00</u>	<u>80,00</u>	<u>2</u>	<u>CR139</u>
<u>27,00</u>	<u>81,70</u>	<u>2</u>	<u>CR392</u>
<u>27,00</u>	<u>81,70</u>	<u>3</u>	<u>CR391</u>
<u>27,00</u>	<u>81,70</u>	<u>12</u>	<u>CR82</u>
<u>27,00</u>	<u>85,00</u>	<u>3</u>	<u>CR83</u>
<u>27,00</u>	<u>85,00</u>	<u>12</u>	<u>CR80</u>
<u>27,00</u>	<u>92,00</u>	<u>3</u>	<u>CR140</u>

FIG. 3

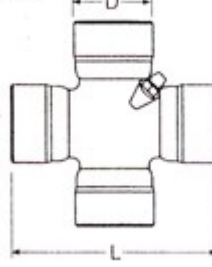

FIG. 6

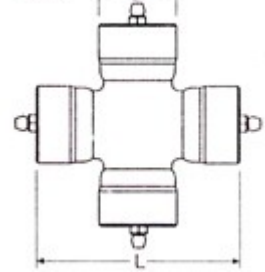
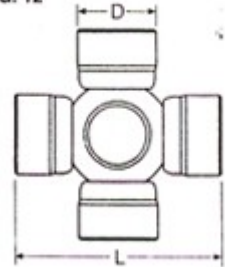

FIG. 12



<u>28,00</u>	<u>70,00</u>	<u>1</u>	<u>CR292</u>
<u>28,00</u>	<u>71,00</u>	<u>1</u>	<u>CR287</u>
<u>D</u>	<u>L</u>	<u>Fig.</u>	<u>Cod</u>
<u>28,00</u>	<u>71,50</u>	<u>1</u>	<u>CR153</u>
<u>28,00</u>	<u>76,50</u>	<u>1</u>	<u>CR154</u>
<u>28,00</u>	<u>80,00</u>	<u>1</u>	<u>CR155</u>
<u>28,00</u>	<u>90,60</u>	<u>12</u>	<u>CR47</u>
<u>28,50</u>	<u>68,00</u>	<u>1</u>	<u>CR285</u>
<u>28,55</u>	<u>61,98</u>	<u>1</u>	<u>CR159</u>
<u>28,57</u>	<u>60,10</u>	<u>1</u>	<u>CR160</u>
<u>28,57</u>	<u>78,00</u>	<u>1</u>	<u>CR161</u>
<u>28,60</u>	<u>66,60</u>	<u>1</u>	<u>CR286</u>
<u>28,60</u>	<u>67,20</u>	<u>2</u>	<u>CR167</u>
<u>28,60</u>	<u>74,60</u>	<u>1</u>	<u>CR284</u>
<u>28,60</u>	<u>78,00</u>	<u>1</u>	<u>CR169</u>
<u>29,00</u>	<u>76,00</u>	<u>2</u>	<u>CR171</u>
<u>29,00</u>	<u>79,00</u>	<u>1</u>	<u>CR172</u>
<u>29,00</u>	<u>80,00</u>	<u>1</u>	<u>CR5</u>
<u>29,00</u>	<u>83,00</u>	<u>1</u>	<u>CR173</u>
<u>30,00</u>	<u>78,20</u>	<u>1</u>	<u>CR180</u>
<u>30,00</u>	<u>81,70</u>	<u>3</u>	<u>CR308</u>
<u>30,00</u>	<u>81,80</u>	<u>1</u>	<u>CR181</u>
<u>30,00</u>	<u>81,80</u>	<u>4</u>	<u>CR182</u>
<u>30,00</u>	<u>81,80</u>	<u>2</u>	<u>CR183</u>
<u>30,00</u>	<u>81,86</u>	<u>1</u>	<u>CR185</u>
<u>30,00</u>	<u>82,40</u>	<u>1</u>	<u>CR186</u>
<u>30,00</u>	<u>83,00</u>	<u>4</u>	<u>CR187</u>
<u>30,00</u>	<u>83,00</u>	<u>1</u>	<u>CR188</u>
<u>30,00</u>	<u>83,00</u>	<u>2</u>	<u>CR189</u>
<u>30,00</u>	<u>85,50</u>	<u>1</u>	<u>CR305</u>
<u>30,00</u>	<u>88,00</u>	<u>1</u>	<u>CR306</u>
<u>30,00</u>	<u>92,00</u>	<u>2</u>	<u>CR309</u>

FIG. 1

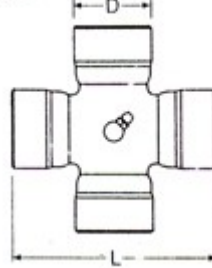

FIG. 2

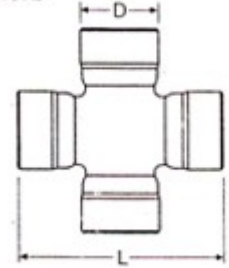

FIG. 3

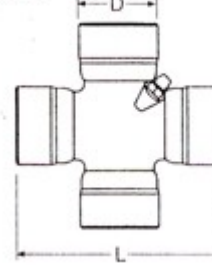

FIG. 4

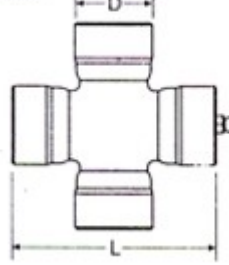

FIG. 5

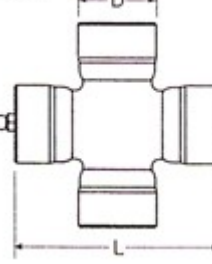

FIG. 6

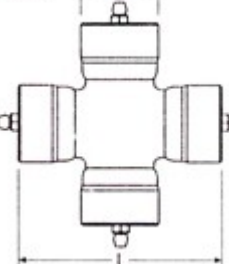
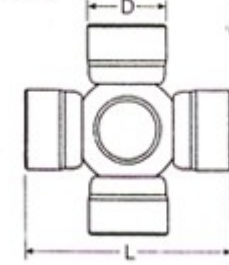
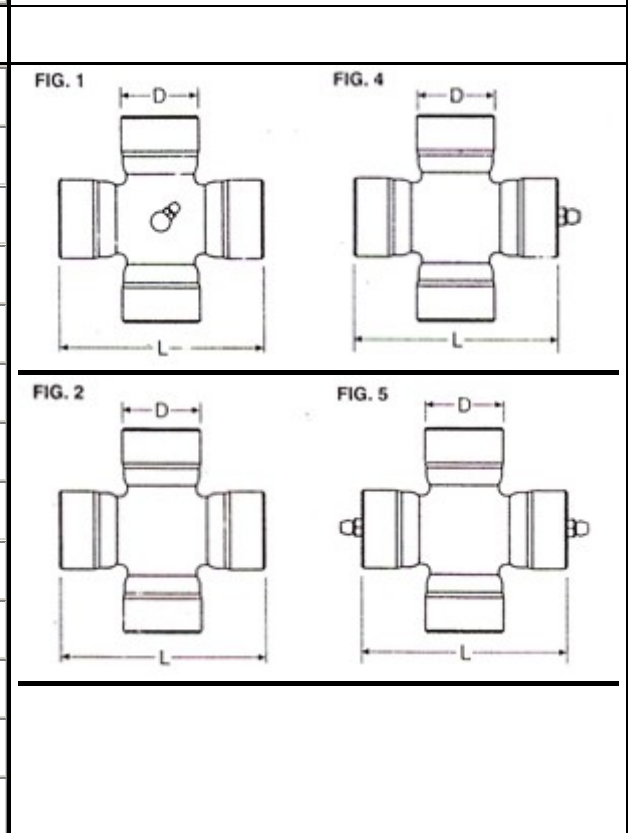
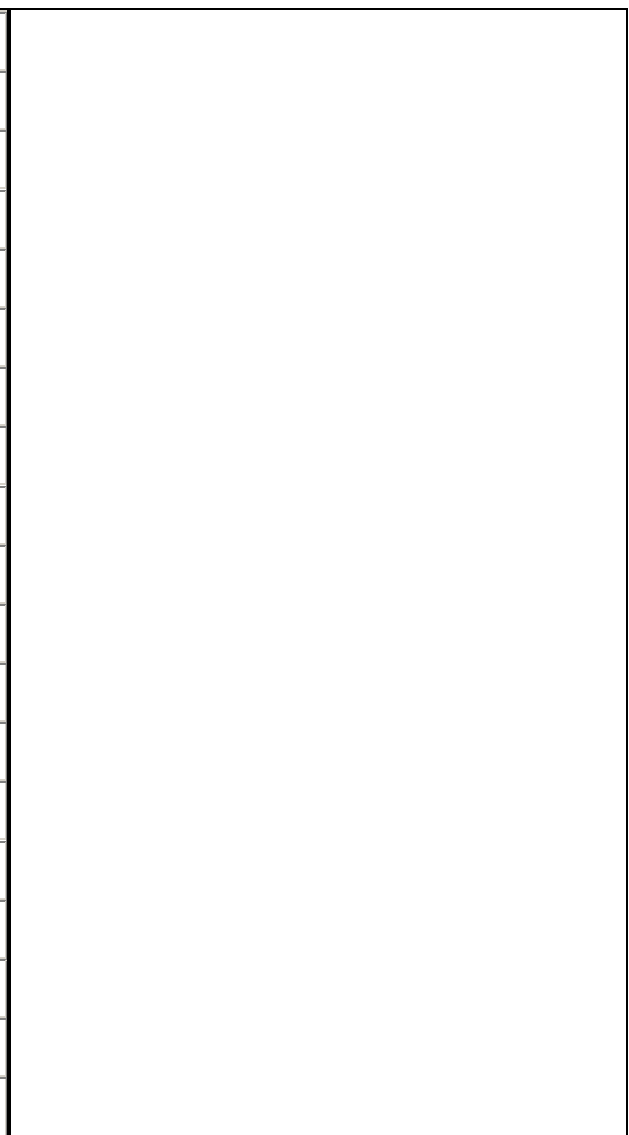

FIG. 12



<u>30,17</u>	<u>80,00</u>	<u>1</u>	<u>CR192</u>
<u>30,17</u>	<u>92,00</u>	<u>1</u>	<u>CR20</u>
<u>30,17</u>	<u>92,00</u>	<u>2</u>	<u>CR978</u>
<u>30,17</u>	<u>92,00</u>	<u>3</u>	<u>CR98</u>
<u>30,17</u>	<u>92,00</u>	<u>5</u>	<u>CR291</u>
<u>30,17</u>	<u>105,30</u>	<u>12</u>	<u>CR280</u>
<u>30,17</u>	<u>106,30</u>	<u>3</u>	<u>CR031</u>
<u>30,17</u>	<u>106,50</u>	<u>1</u>	<u>CR21</u>
<u>30,20</u>	<u>80,00</u>	<u>1</u>	<u>CR11</u>
<u>30,20</u>	<u>82,00</u>	<u>1</u>	<u>CR200</u>
<u>30,20</u>	<u>82,00</u>	<u>4</u>	<u>CR201</u>
<u>30,20</u>	<u>82,00</u>	<u>2</u>	<u>CR294</u>
<u>30,20</u>	<u>82,00</u>	<u>5</u>	<u>CR202</u>
<u>30,20</u>	<u>86,70</u>	<u>1</u>	<u>CR307</u>
<u>30,20</u>	<u>90,00</u>	<u>1</u>	<u>CR302</u>
<u>30,20</u>	<u>92,00</u>	<u>1</u>	<u>CR6</u>
<u>30,20</u>	<u>99,00</u>	<u>1</u>	<u>CR203</u>
<u>30,20</u>	<u>106,50</u>	<u>1</u>	<u>CR7</u>
<u>31,00</u>	<u>88,00</u>	<u>2</u>	<u>CR318</u>

<u>31,00</u>	<u>90,00</u>	<u>1</u>	<u>CR319</u>
<u>31,77</u>	<u>81,45</u>	<u>4</u>	<u>CR210</u>
<u>31,77</u>	<u>81,45</u>	<u>1</u>	<u>CR211</u>
<u>32,00</u>	<u>76,00</u>	<u>1</u>	<u>CR29</u>
<u>32,00</u>	<u>80,00</u>	<u>1</u>	<u>CR328</u>
<u>32,00</u>	<u>86,00</u>	<u>1</u>	<u>CR326</u>
<u>32,00</u>	<u>90,30</u>	<u>3</u>	<u>CR268</u>
<u>32,00</u>	<u>92,00</u>	<u>1</u>	<u>CR329</u>
<u>32,00</u>	<u>93,00</u>	<u>1</u>	<u>CR323</u>
<u>32,00</u>	<u>95,60</u>	<u>1</u>	<u>CR325</u>
<u>32,00</u>	<u>97,00</u>	<u>1</u>	<u>CR212</u>
<u>32,00</u>	<u>106,30</u>	<u>3</u>	<u>CR99</u>
<u>34,00</u>	<u>89,00</u>	<u>1</u>	<u>CR216</u>



<u>34,00</u>	<u>96,80</u>	<u>1</u>	<u>CR349</u>
<u>34,00</u>	<u>97,00</u>	<u>4</u>	<u>CR217</u>
<u>34,00</u>	<u>97,00</u>	<u>1</u>	<u>CR218</u>
<u>34,00</u>	<u>99,00</u>	<u>2</u>	<u>CR219</u>
<u>34,00</u>	<u>106,50</u>	<u>1</u>	<u>CR60</u>
<u>34,90</u>	<u>92,20</u>	<u>1</u>	<u>CR220</u>
<u>34,90</u>	<u>92,20</u>	<u>4</u>	<u>CR221</u>
<u>34,90</u>	<u>92,20</u>	<u>5</u>	<u>CR223</u>
<u>34,90</u>	<u>104,00</u>	<u>1</u>	<u>CR229</u>
<u>34,90</u>	<u>106,40</u>	<u>1</u>	<u>CR230</u>
<u>34,90</u>	<u>106,40</u>	<u>4</u>	<u>CR231</u>
<u>34,90</u>	<u>106,40</u>	<u>5</u>	<u>CR232</u>
<u>34,92</u>	<u>94,00</u>	<u>1</u>	<u>CR70</u>
<u>34,92</u>	<u>106,20</u>	<u>3</u>	<u>CR233</u>
<u>34,92</u>	<u>106,30</u>	<u>1</u>	<u>CR234</u>
<u>34,92</u>	<u>106,50</u>	<u>1</u>	<u>CR8</u>
<u>34,92</u>	<u>127,10</u>	<u>3</u>	<u>CR237</u>
<u>34,92</u>	<u>106,50</u>	<u>1</u>	<u>CR23</u>
<u>35,00</u>	<u>89,00</u>	<u>1</u>	<u>CR239</u>
<u>35,00</u>	<u>96,80</u>	<u>1</u>	<u>CR22</u>
<u>35,00</u>	<u>96,80</u>	<u>2</u>	<u>CR226</u>
<u>35,00</u>	<u>97,00</u>	<u>1</u>	<u>CR274</u>
<u>35,00</u>	<u>107,50</u>	<u>1</u>	<u>CR271</u>
<u>36,00</u>	<u>89,00</u>	<u>1</u>	<u>CR27</u>
<u>36,00</u>	<u>97,00</u>	<u>1</u>	<u>CR242</u>
<u>38,00</u>	<u>89,20</u>	<u>1</u>	<u>CR250</u>
<u>38,00</u>	<u>105,80</u>	<u>1</u>	<u>CR381</u>
<u>38,00</u>	<u>105,80</u>	<u>4</u>	<u>CR251</u>
<u>38,00</u>	<u>106,00</u>	<u>4</u>	<u>CR252</u>
<u>38,00</u>	<u>106,00</u>	<u>1</u>	<u>CR253</u>
<u>38,00</u>	<u>110,00</u>	<u>1</u>	<u>CR254</u>
<u>39,00</u>	<u>116,40</u>	<u>1</u>	<u>CR255</u>
<u>39,00</u>	<u>127,00</u>	<u>3</u>	<u>CR256</u>

FIG. 3

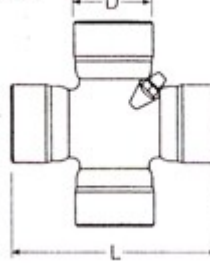

FIG. 6

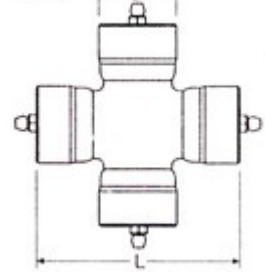
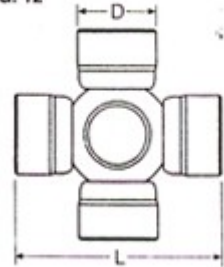

FIG. 12



<u>39,69</u>	<u>115,90</u>	<u>3</u>	<u>CR257</u>	
<u>39,98</u>	<u>118,00</u>	<u>1</u>	<u>CR258</u>	
<u>40,01</u>	<u>123,80</u>	<u>1</u>	<u>CR259</u>	
<u>41,00</u>	<u>106,00</u>	<u>1</u>	<u>CR411</u>	
<u>41,00</u>	<u>108,00</u>	<u>1</u>	<u>CR90</u>	
<u>41,00</u>	<u>118,00</u>	<u>1</u>	<u>CR9</u>	
<u>42,00</u>	<u>104,00</u>	<u>1</u>	<u>CR24</u>	
<u>42,00</u>	<u>104,50</u>	<u>1</u>	<u>CR260</u>	
<u>42,00</u>	<u>104,50</u>	<u>4</u>	<u>CR261</u>	
<u>42,00</u>	<u>106,00</u>	<u>1</u>	<u>CR262</u>	
<u>42,00</u>	<u>117,50</u>	<u>1</u>	<u>CR272</u>	
<u>42,00</u>	<u>119,40</u>	<u>1</u>	<u>CR263</u>	
<u>42,00</u>	<u>123,00</u>	<u>1</u>	<u>CR264</u>	
<u>42,00</u>	<u>123,00</u>	<u>2</u>	<u>CR265</u>	
<u>42,00</u>	<u>123,00</u>	<u>4</u>	<u>CR266</u>	